

# Self-pulverization Mill for grain especially Rice

# **SUPER POWDER MILL**

## Summary

In milling, it's important to utilize essential ingredients of rice which are different from one of wheat. Self-pulverization Mill machine "Super powder mill" is evaluated now, because it prevents starch damage and starch gelatinization, and it can control moist and crumb up in sharp grain size distribution.

## Features

This machine:

- can do by Semi-Wet milling and brown rice milling.
- rarely causes starch damage because of Self-mill grinding method which grinds among raw materials. The method makes smaller impact power in grinding and crush finishes for a short time.
- yields air much, and doesn't rise so much because this machine roles grinding medium. There is in no danger of starch gelatinization.
- make materials stay inside machine until it is broken up as set up, so the size of grain at D50 is fine and sharp grain size distribution.
- reduce load of sieving machine thanks to sharp grain size distribution.
- stabilize water content ratio after grind by corporation of flash drying.
- is easy to open and close casing, so you can clean this easily.



## Construction

Rotor and upside fan are fixed at shaft supported by top and bottoms bearing. Casing is outside of that, and there is block construction based on hinge part of casing and pillar supporting bearing and mortar. They build up with driving part inside bed. Casing has supply port at the bottom and fan room at the top, specially-shaped liner is fixed in crushing underside, blade is assembled at rotor radially. When rotor or fan revolves at high speed, crushed material and air are sucked into grind room from sending machine. Swirling airflow is generated among blade and liner and rotor number of stage set in grinding room. The materials are crushed finely by repeating breakup and friction among grains by crash to liner and fast spinning. And the materials climb upward with regulating rise in speed by orifice plate. Intended grains are ejected outside machine by top fan.

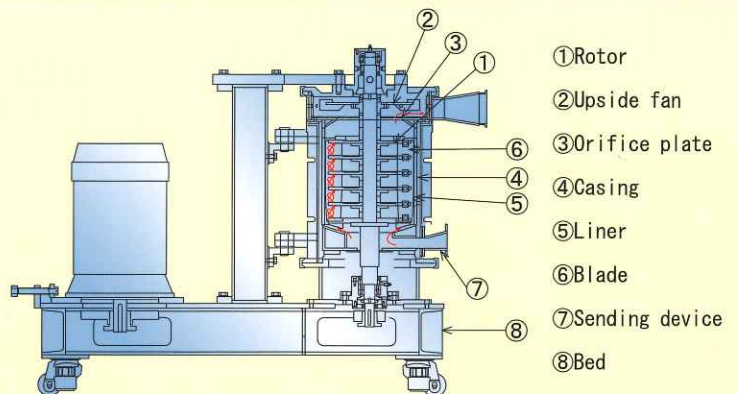

Model	SPM-R200	SPM-R290	SPM-R430	SPM-R750	SPM-R1050
Capacity(Kg/hr)	~30	30~100	100~200	200~600	600~1000
Rotor Dia.(φ)	180	290	430	750	1050
Motor(Kw)	3.7	15	37	110	220
R.P.M (rpm)	~8000	~6200	~3950	~2500	~1800
Air amount (m <sup>3</sup> /min)	~3.0	~10	~16	~30	~50
Weight (kg)	220	650	1200	3200	6500

※Ability differs substantially the type of rice, depending upon grain size, moisture value and pulverization target particle diameter.

# SUPER POWDER MILL

The particle photograph by the electron microscope

## [Rice flour]

By only pin-mill over Dry process, others over Semi-Wet process.

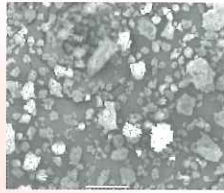

by Super powder mill

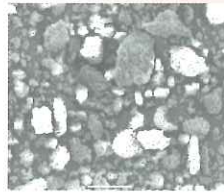

by Stamp-mill

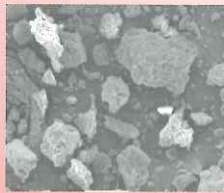

by Roll-mill

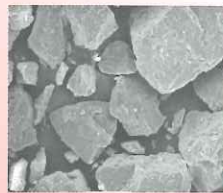

by Pin-mill

## [Wheat flour]

By roll-mill over Dry process



Enriched flour



Plain flour

Distribution of particle diameter by Super Powder Mill over Semi-Wet process:

Test condition	
Size before milling	Whole rice (not broken)
Before the milling moisture	30%
After the milling moisture	13%
Average size after milling	30um
Range size after milling	10~100um
Starch damage ratio	3.2%

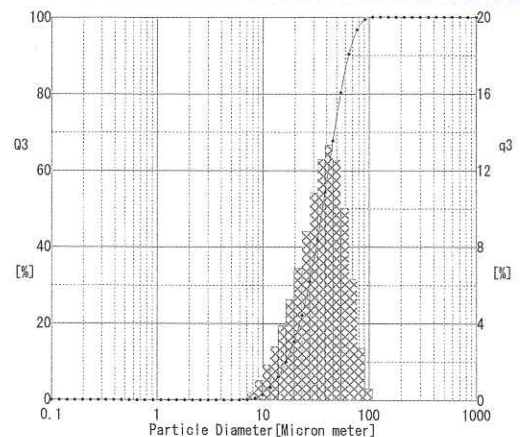

Milling and Drying Labo-Plant for Semi-Wet process (~100kg/hr)

Model:SPM-R290

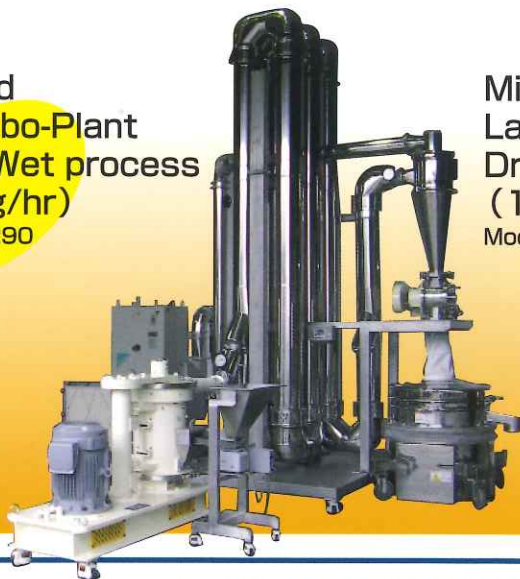

Milling Labo-Plant for Dry/Wet process (10~30kg/hr)

Model:SPM-R200



 株式会社 西村機械製作所

NISHIMURA MACHINE WORKS CO.,LTD.

[Head Office&Lab.]  
2-6-9 Matsuyama-cho Yao-city  
Osaka 581-0088 Japan  
tel.+81-72-991-2461  
fax.+81-72-993-6334

[Tokyo branch]  
7-16 Nihonbashi-Kodenma-cho  
Chuo-ku Tokyo 103-0011 Japan  
tel.+81-3-3808-1091  
fax.+81-3-3808-0928

<http://www.rice-flour.jp> e-mail: [info@econmw.co.jp](mailto:info@econmw.co.jp)

agency: